

1 2 3 4 5 6 7 8

⚠ RoHS Compliant

REV	MODIFICATION	DATE	DRAW
A0	Release To Product	2011.09.20	Ivy
A1	Release To ECN20130313	2013.03.29	Seven

A

B

C

D

E

F

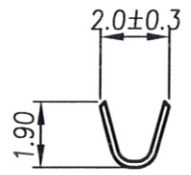
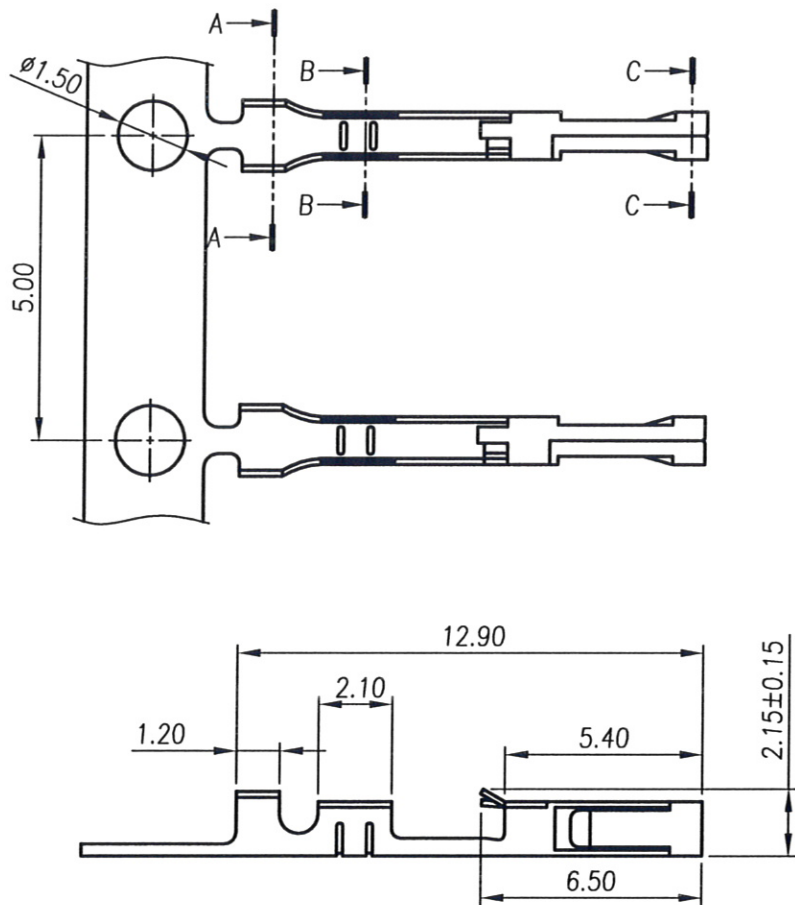

SEC. A-A

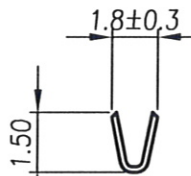

SEC. B-B

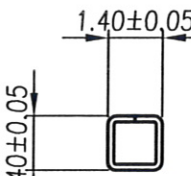

SEC. C-C

Part No.: CC0380000P X A5
 Plating _____
 1: Bright Tin Plated
 3: Gold Flash



捲料方向：如圖收捲料

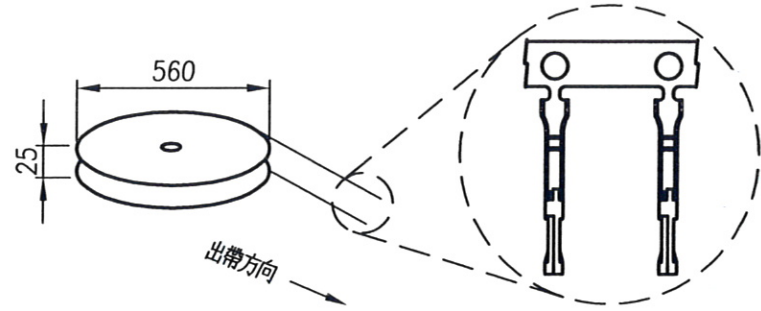

端子須向軸心方向, 料帶朝上方

Specifications & Ordering Information:

Part No	Thickness	Material	Wire Range	Insulation O.D.
CC0380000PXA5	0.20mm	Phosphor Bronze	AWG #24~30	1.40~1.10mm

Finish	Qty/reel	Use With(Housing)
See P/N	15,000PCS	BC038XXXX73B8



金上達科技股份有限公司

GOLDENSUNDA TECHNOLOGY CO.,LTD

TOLERANCE UNLESS OTHERWISE SPECIFIED		PROJ. 	TITLE: Wire To Board Terminal 2.54mm			
.x± 0.35	x.* 2'	APR. Jay 20130329	PART NO. CC0380000PXA5		DWG NO. CC0380000PXA5	
.xx± 0.25	.x.* 1'	CHK. Michelle 20130329	UNITS: mm	CUSTOMER DRAWING		
.xxx± 0.15	.xx.* 0.5'	DRA. Seven 20130329	SIZE: A4	SCALE 8:1	SHEET 1 / 1	
			REV A1	V		

1 2 3 4 5 6 7 8