

RoHS Compliant

REV	MODIFICATION	DATE	DRAW
A0	Refer to MA20150401	2015.04.28	Michelle

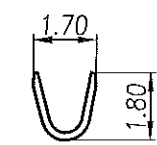

SEC. A-A

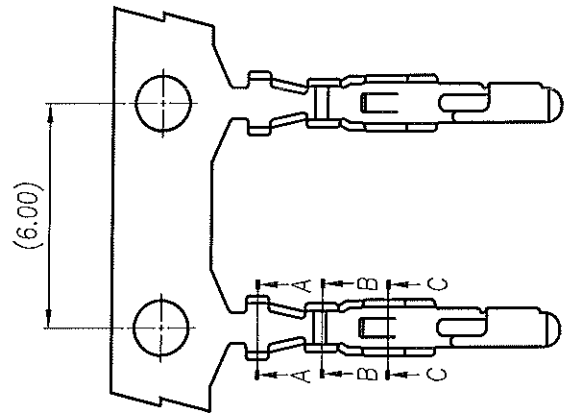
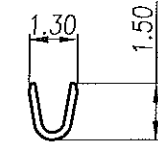

SEC. B-B

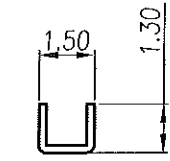

SEC. C-C

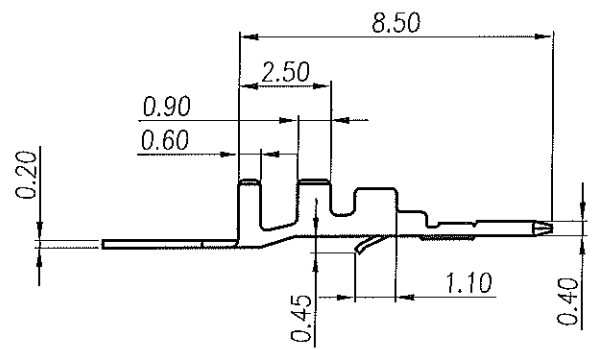



Part No.: CCA130100P X A4

Plating  
1: Bright Tin Plated Over Nickel



Specifications & Order Information:

Part No	Thickness	Material	Wire Range	Insulation O.D.
CCA130100PXA4	0.20mm	Phosphor Bronze	AWG #24~28	0.90~1.15mm
Finish	Qty/reel	Mates With(Housing)		
See P/N	15,000PCS	BCA1301XX1253		

		<b>金上達科技股份有限公司</b> <b>GOLDENSUND TECHNOLOGY CO.,LTD</b>	
TOLERANCE UNLESS OTHERWISE SPECIFIED		TITLE: Wire To Wire Terminal 2.00mm Male	
.X± 0.35	X.± 2'	PROJ.  APR. C.F. Liao 20150428	PART NO. CCA130100PXA4
.XX± 0.25	.X± 1'	CHK. Abel 20150428	DWG NO. CCA130100PXA4
.XXX± 0.15	.XX± 0.5'	DRA. Michelle 20150428	UNITS: mm SCALE FREE SHEET 1 / 1 REV A0
SIZE: <b>A4</b>		CUSTOMER DRAWING	