

RoHS Compliant

REV	MODIFICATION	DATE	DRAW
A0	Refer to MA2050401	2015.04.28	Michelle

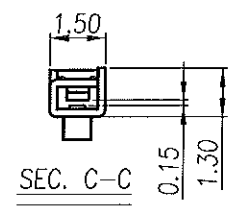

Part No.: CCA130000P X A4
 Plating
 1: Bright Tin Plated Over Nickel

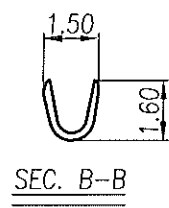
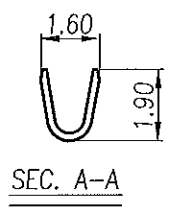
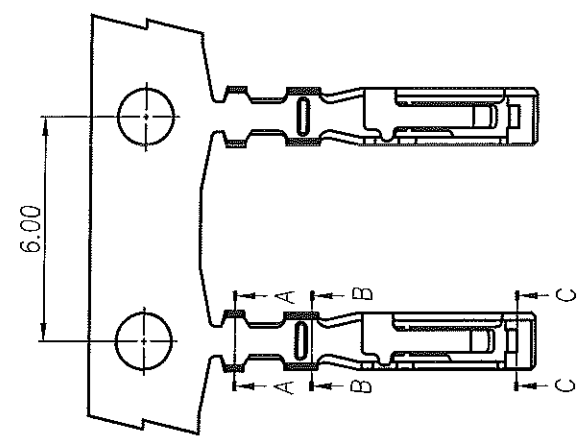
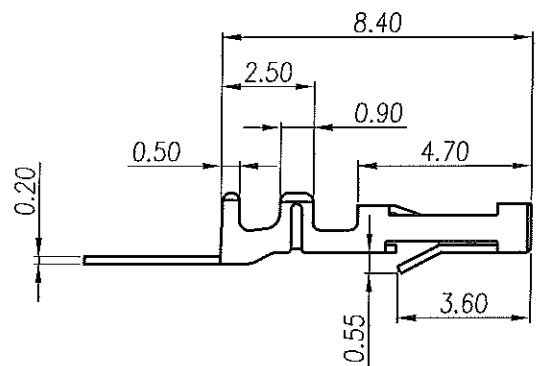

Specifications & Ordering Information:

Part No	Thickness	Material	Wire Range	Insulation O.D.
CCA130000PXA4	0.20mm	Phosphor Bronze	AWG #24~28	0.90~1.15mm

Finish	Qty/reel	Mates With(Housing)
See P/N	15,000PCS	BCA1300XX1253



金上達科技股份有限公司

GOLDENSUND TECHNOLOGY CO.,LTD

TOLERANCE UNLESS OTHERWISE SPECIFIED		PROJ. 	TITLE: Wire To Wire Terminal 2.00mm Female	
.X± 0.35	X'± 2'	APR. C.F. Liao 20150428	PART NO. CCA130000PXA4	DWG NO. CCA130000PXA4
.XX± 0.25	.X'± 1'	CHK. Abel 20150428	CUSTOMER DRAWING	
.XXX± 0.15	.XX'± 0.5'	DRA. Michelle 20150428		
		UNITS: mm	SIZE: A4	SCALE: FREE
		SHEET 1 / 1		REV: A0 V