

REV	MODIFICATION	DATE	DRAW
A0	Release To ECN20150704	2015.07.16	Michelle

RoHS Compliant

Specification

- 1.Current Rating:1A AC
- 2.Contact Resistance:20mΩ Max.
- 3.Insulation Resistance:1000MΩ Min.
- 4.Dielectric Withstanding Voltage:AC300V/Minute
- 5.Operating Temperature:-40°C~+105°C

Material:

- 1.Housing:High Temperature Thermoplastic UL94V-0
- 2.Contact Pin:Copper Alloy T=0.15mm

Finish:

- 1.Housing:Black
- 2.Contact Pin:Gold Plated 0.60u" Min Over Nickel 40u" Min.

Part No.: ES01625 10 A 3 R 3

No. Of Pin
2x5Pin(10P)

Packing
R:T&R

Housing Material
A:NY9T UL94V-0 Black

Plating
3:Gold Plated 0.60u" Min.
Over Nickel 40u" Min.

Notes:

- "*":Indicates The Key Dimensions.
- "▲":Indicates The Mating Dimensions.

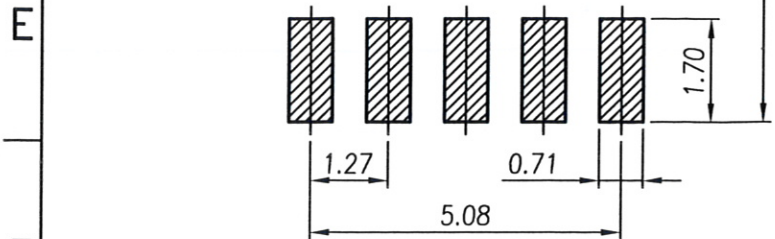
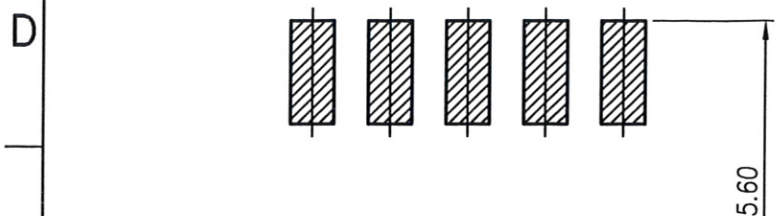
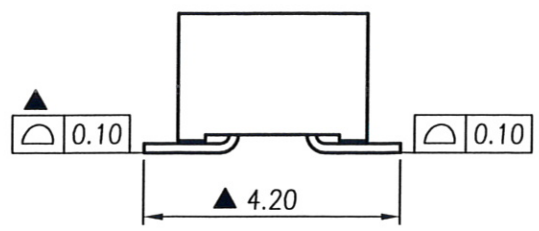
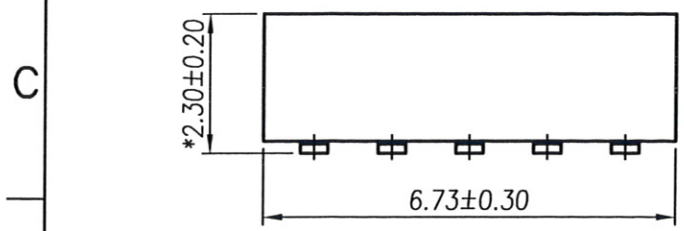
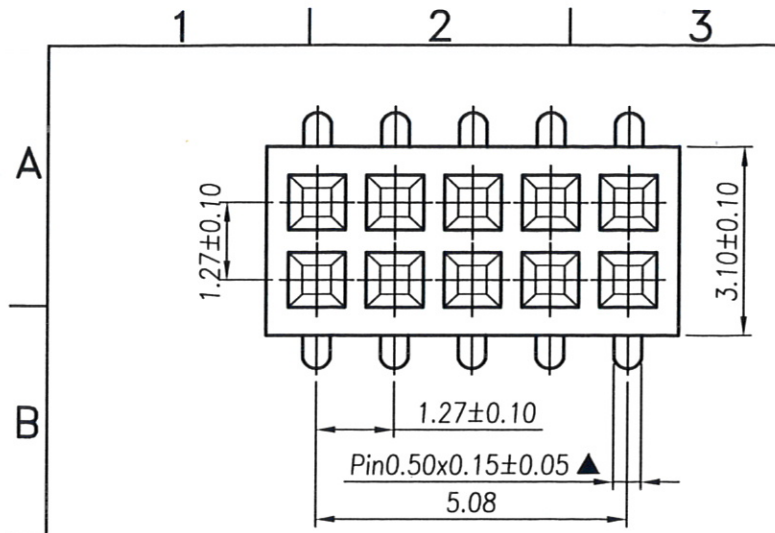

RECOMMENDED P.C.B LAYOUT

TOLERANCE UNLESS OTHERWISE SPECIFIED				PROJ.		TITLE: Female Header 1.27mm 2x5Pin 180° H=2.10 SMT Dual Row			
.x± 0.35	x:± 2'	APR. C.F. Liao 20150716	PART NO. ES0162510A3R3		DWG NO. ES0162510A3R3				
.xx± 0.25	.x:± 1'	CHK. Abel 20150716	UNITS: mm		CUSTOMER DRAWING				
.xxx± 0.15	.xx:± 0.5'	DRA. Michelle 20150716	SIZE: A4		SCALE 8:1		SHEET 1 / 2		REV A0

RoHS Compliant

REV	MODIFICATION	DATE	DRAW
A0	Release To ECN20150704	2015.07.16	Michelle

A

B

C

D

E

F

A

B

C

D

E

F

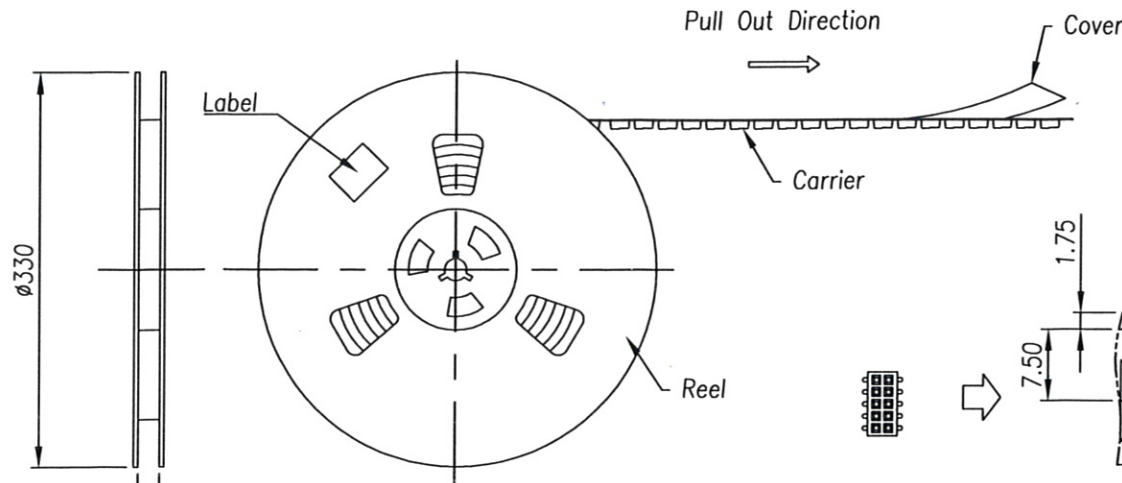

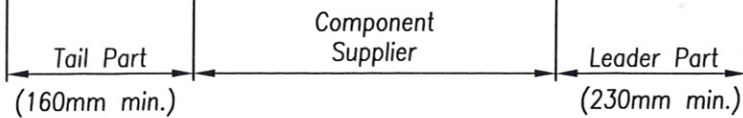
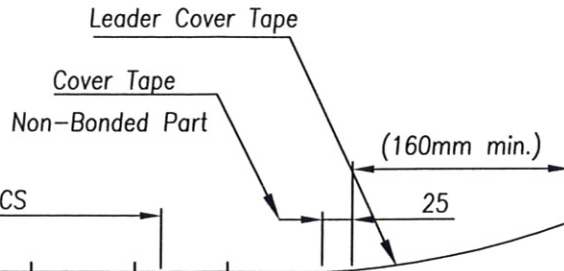
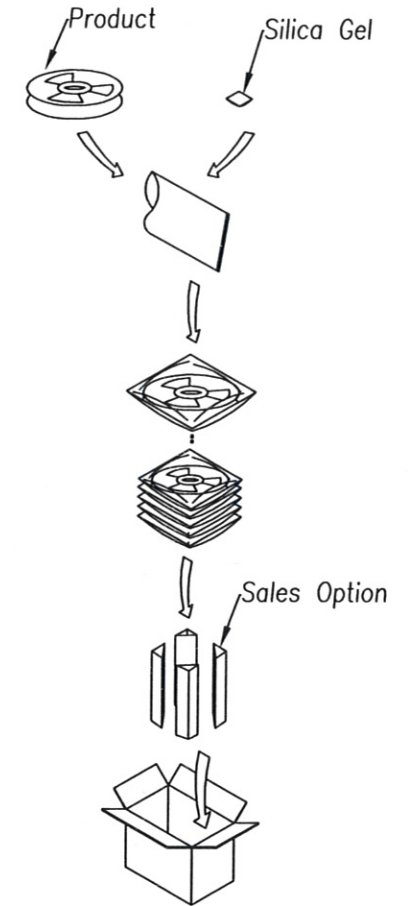
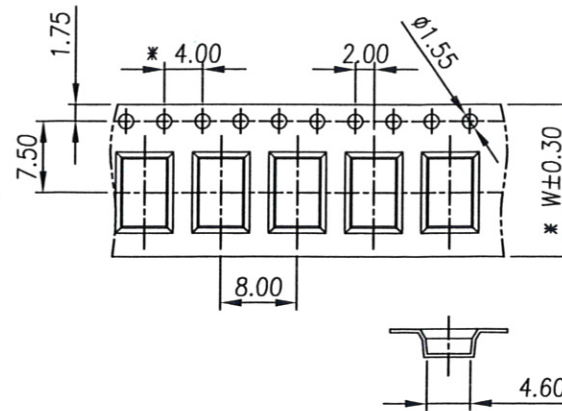

Carrier For 2x5Pin(10P)

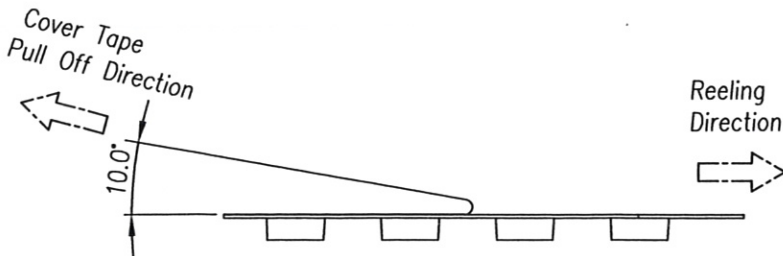

Notes:
1.Part No.: ES0162510A3R3

PIN NO.	W	PCS/REEL
2x5Pin(10P)	16	1500



 金上達科技股份有限公司 GOLDENSUNDA TECHNOLOGY CO.,LTD			
TOLERANCE UNLESS OTHERWISE SPECIFIED		PROJ. 	TITLE: Female Header 1.27mm 2x5Pin 180° H=2.10 SMT Dual Row
.x± 0.35	x.'± 2'	APR. C.F. Liao 20150716	PART NO. ES0162510A3R3
.xx± 0.25	.x'± 1'	CHK. Abel 20150716	DWG NO. ES0162510A3R3
.xxx± 0.15	.xx'± 0.5'	DRA. Michelle 20150716	UNITS: mm
SIZE: A4		CUSTOMER DRAWING	
SCALE Free		SHEET 2 / 2	REV A0